

Physique 40S  
Exemples : circuits

---

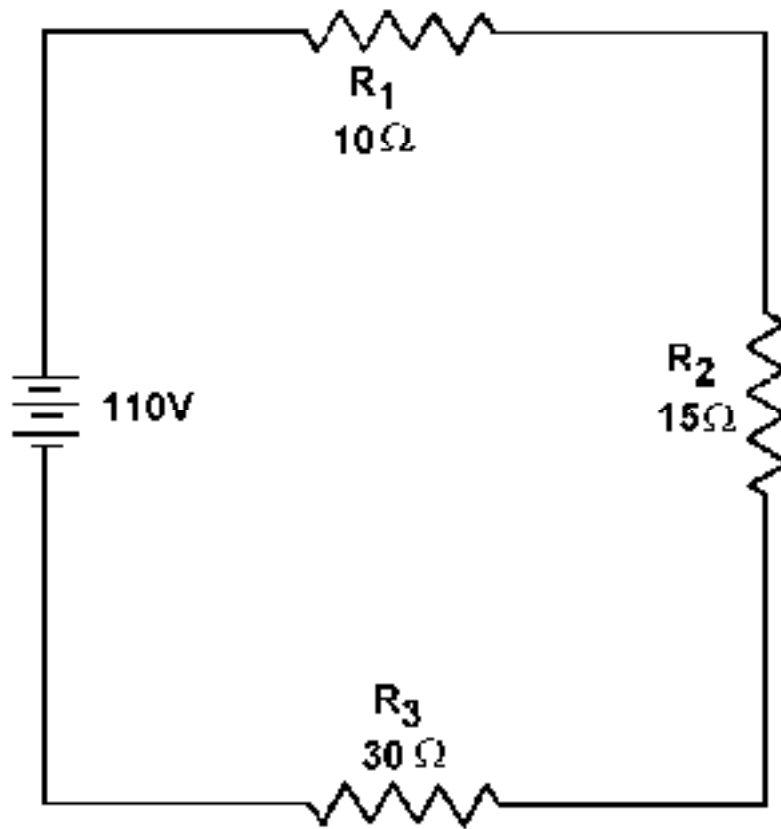

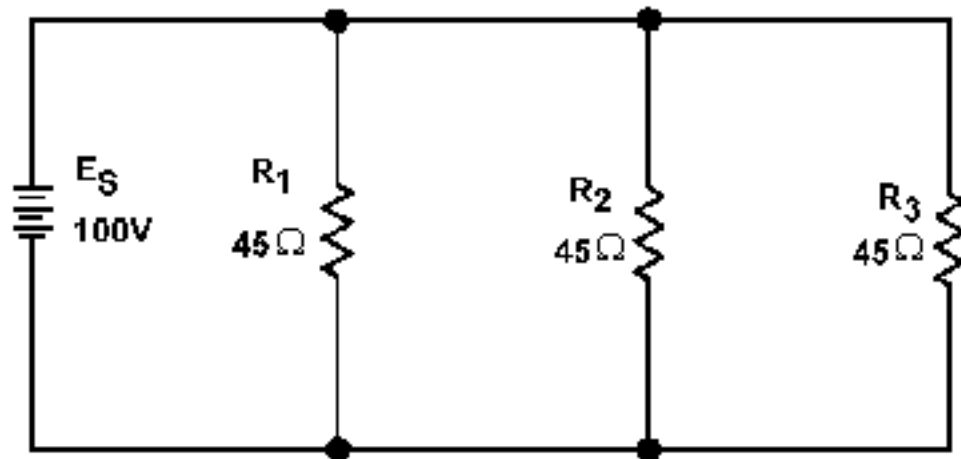

(A)

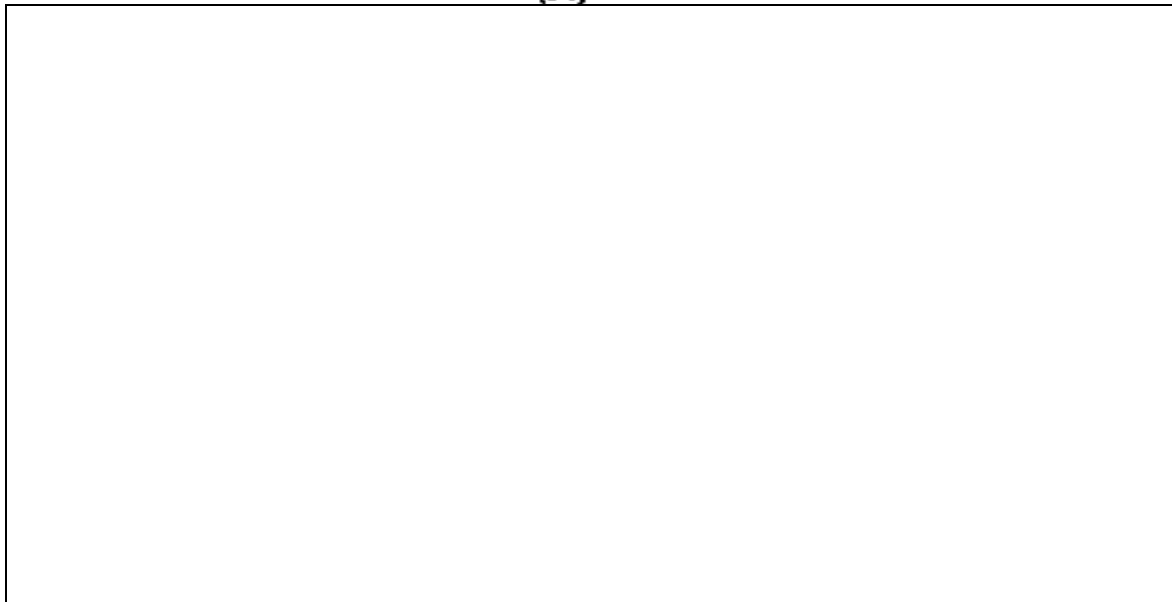

(B)

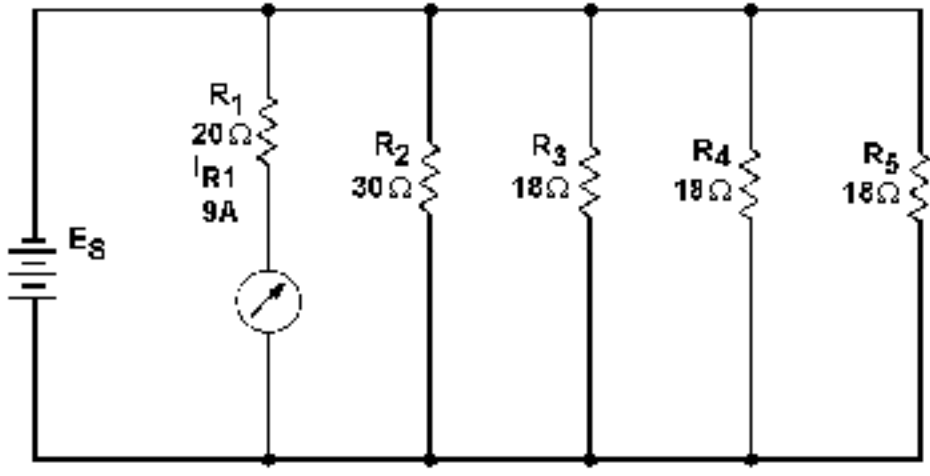

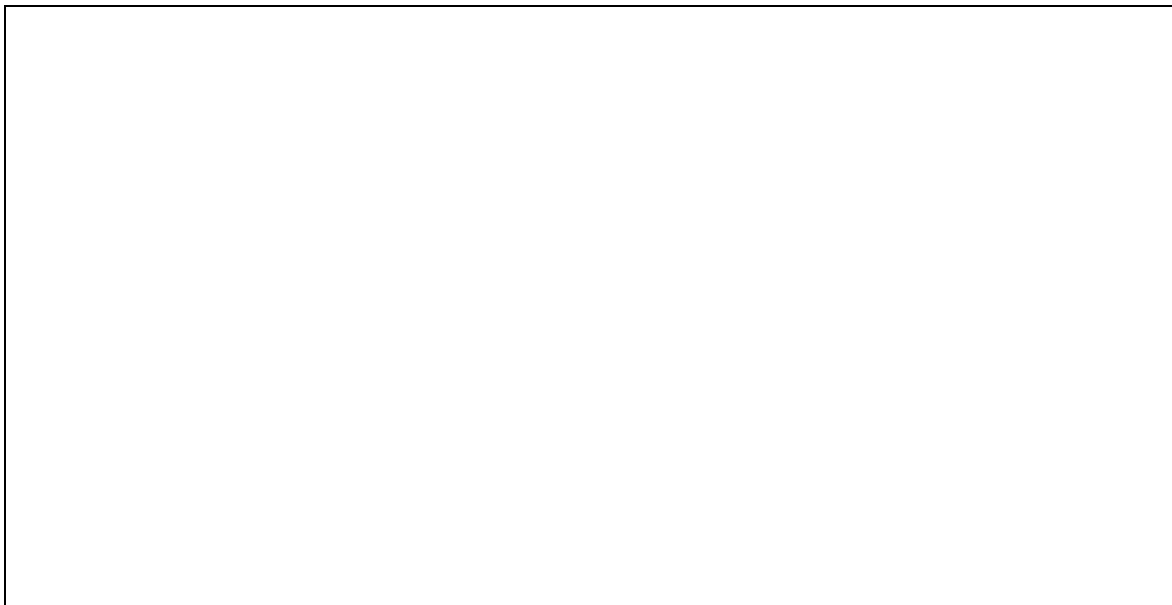
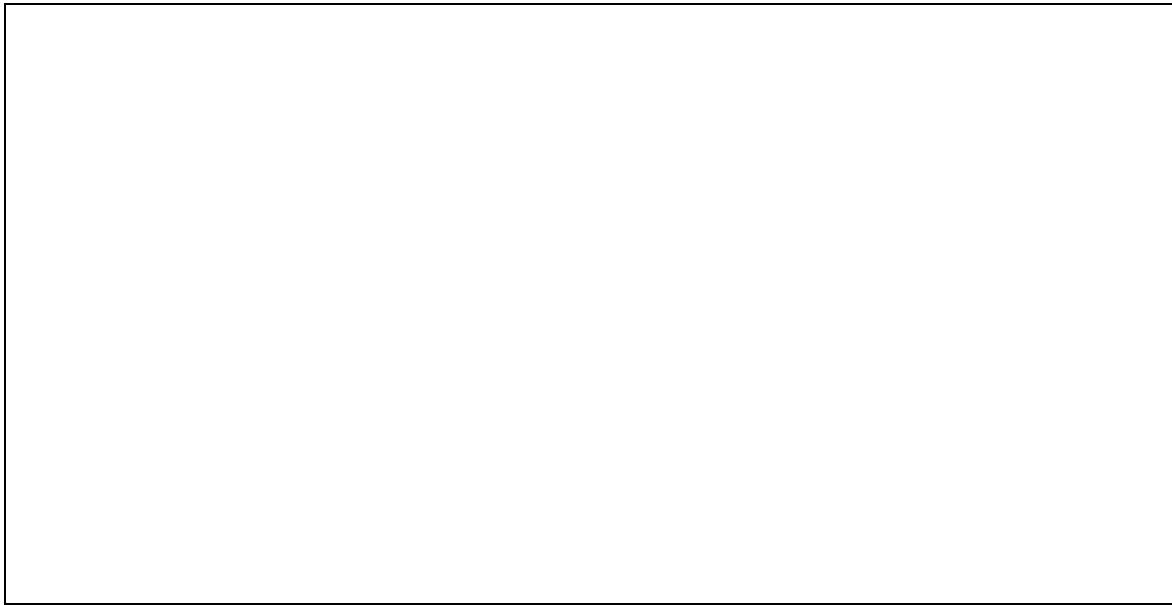
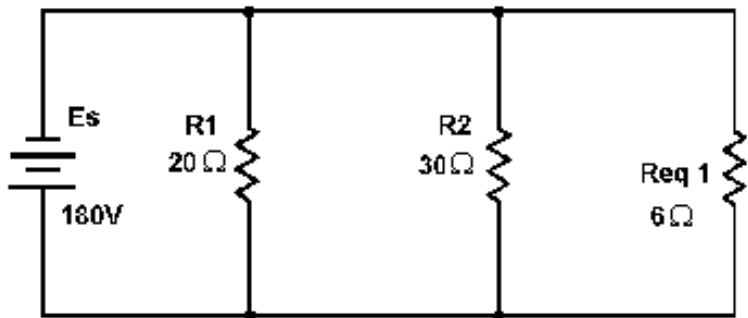

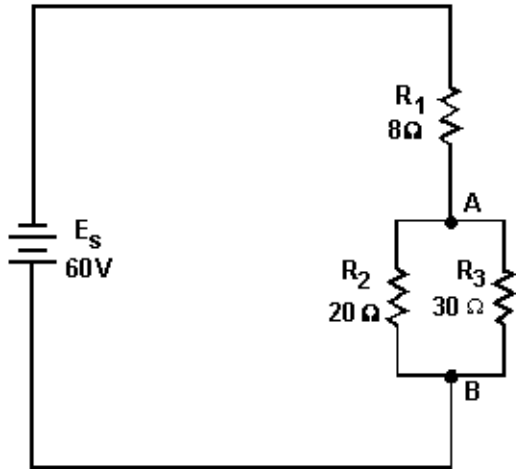

(A)

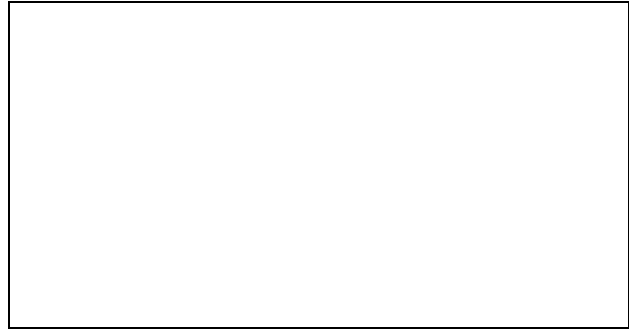

(B)

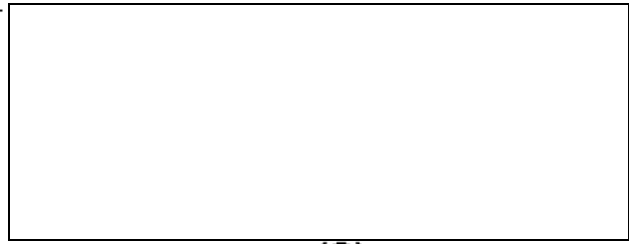

(C)

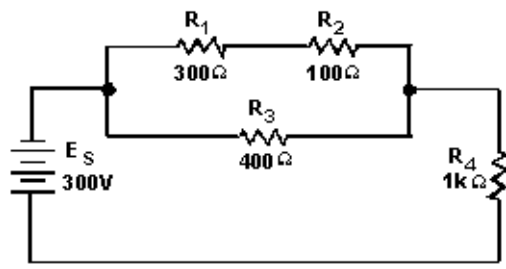

(A)

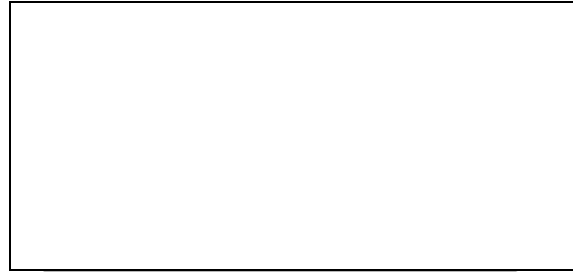

(B)

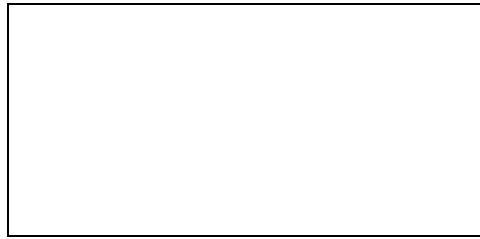

(C)

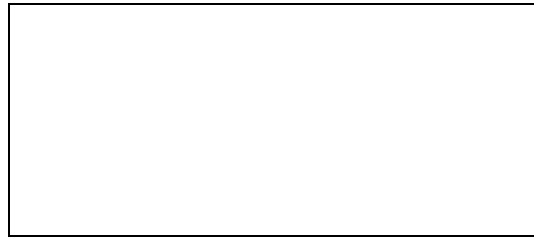

(D)

Redessiner des circuits

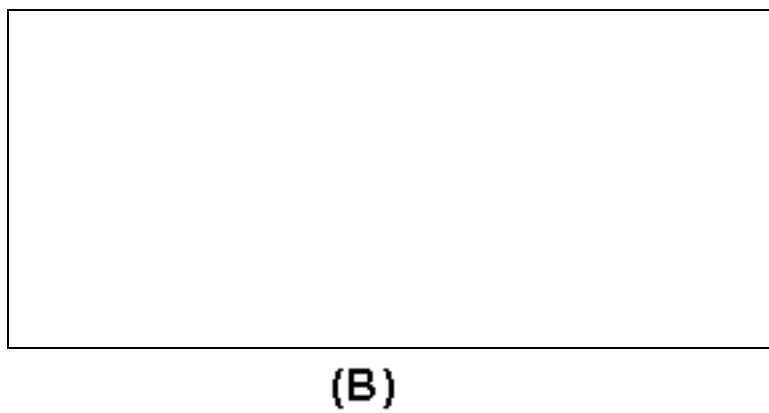
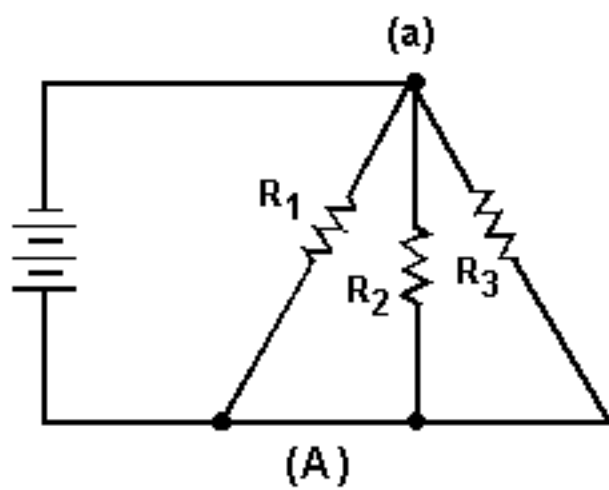

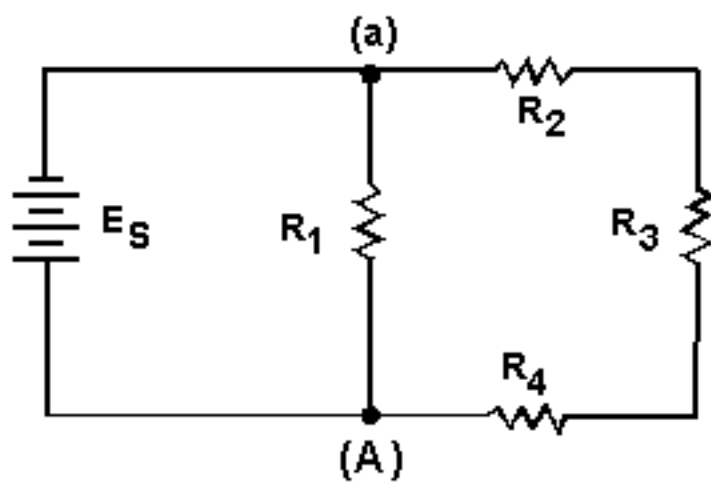

(B)



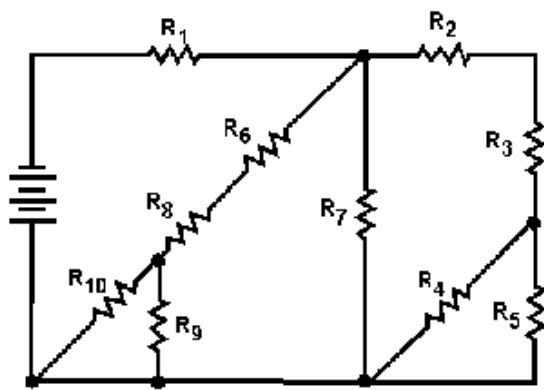

(A)



(B)

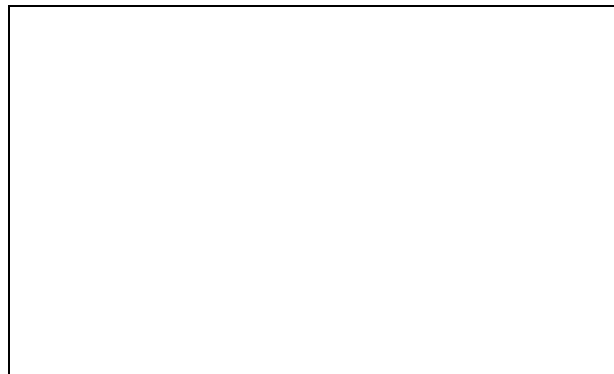

(C)

